

Window Locking



Whitco[®]
SECURING YOUR HOME™

10YEAR MECHANICAL
WARRANTY

whitco.com.au

Contents



CYL4® Push Lock

page 4



CYL4® Mini Push Lock

page 6



CYL4® Multi Bolt

page 7



CYL4® Patio Bolt

page 8



CYL4® Window Bolt

page 10



CYL4® Mini Window Bolt

page 11



Keyed Sash Lock

page 12



Safety Sash Lock

page 13



Sliding Window Lock (Diecast)

page 15



Series 25 Window Lock

page 18

Overview



CYL4® is a patented innovation that allows ASSA ABLOY window locks and patio bolts to be keyed to door locks that use the most common key type (C4), thus providing customers with the added convenience of having to use only one key around the home.

Most Australian door locks are operated by a C4 key. Traditional window locks are incompatible with a C4 key. Therefore homeowners are required to carry at least one key for their door locks, and a different key (or keys) for their window locks.

The introduction of ASSA ABLOY's unique CYL4® technology has revolutionised home locking security. Our CYL4® window lock and chainwinder ranges incorporate the patented CYL4® cylinder which is quickly and easily keyed alike to your customer's 5 pin C4 door key.

From this...



To this



The ASSA ABLOY Key Gauge, provided in the CYL4® Keying Kit, allows fast and accurate determination of the key code.

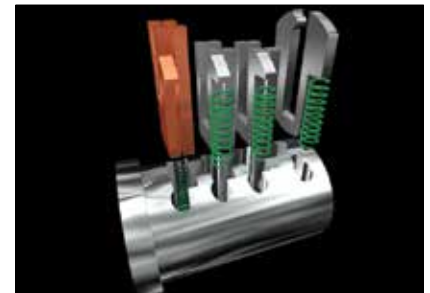

The patented CYL4® cylinder has been designed to retain its wafers when the key is removed. This makes re-keying the CYL4® cylinder quick and easy for retailers and locksmiths alike.

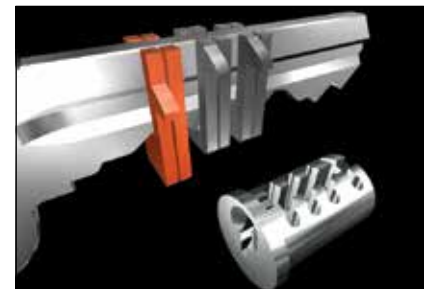

There are 10 CYL4® wafers numbered 0-9, that cover the 10 depths of a C4 key. Six wafers are arranged in pairs to match the first 3 cuts of the customer's key.



Using the CYL4® Keying Kit, you can re-key any ASSA ABLOY CYL4® window lock or patio bolt to the customer's C4 key in just a few minutes. EASY!

CYL4® Push Lock

Application / Description

High security CYL4® sliding window lock with concealed fixing.

Features and Specifications

- CYL4® One Key Security - Can be matched to most door locks for one key convenience
- High security, robust construction, resists attack
Added security for sliding windows
- Solid zinc diecast metal body
- Simply push button to lock
- Enables fixed ventilation
- Standard and one way fixing screws supplied
- Concealed fixing for security and style
- 2 drilling jigs included
- Side fix packer / jig
- Installation kit included for front and side fixing

Available in Display and Trade Packs.

Keying

- CYL4® cylinder - Can be Keyed Alike to all door locks that use a 5 pin key with a C4 profile, and to CYL4® window locks.
- Or - 5 disc wafer cylinder - Can be Keyed Alike to other Whitco 5 disc products.
- Two Whitco keys included



Standard polyester powder coat finishes	
Silver	11
Mahogany	12
White	16
Black	17
Primrose	19

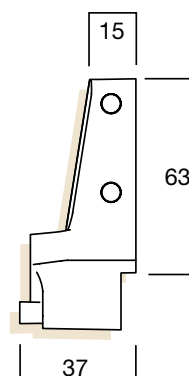
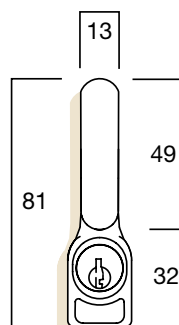

CYL4® Push Lock

Display Pack

Includes Face Fix Drilling Jig, Side Fix Drilling Jig & Packer, 1.5mm, 2.5mm & 5mm Packers

Single Pack - CYL4 Cylinder	W22001••
Quad Pack - Keyed Alike - CYL4 Cylinder	W22004••

Trade Pack

Includes Face Fix Drilling Jig, Side Fix Drilling Jig & Packer, 1.5mm, 2.5mm & 5mm Packers

CYL4 Cylinder - Keyed Alike	W22013••C4
5 Disc Wafer Cylinder - Keyed Alike	W22013••D5

Fabricator Pack

No Drill Jig or Instructions included

CYL4 Cylinder	W22014••C4
5 Disc Wafer Cylinder	W22014••D5

Lock with Offset Keeper

Includes Packers, Rivets and Screws

5 Disc Wafer Cylinder	W22016••D5
-----------------------	------------

Accessories

Plain Offset Fix Keeper	Black	W2200217
-------------------------	-------	----------

•• Denotes finish. See price list for available pack / finish combinations

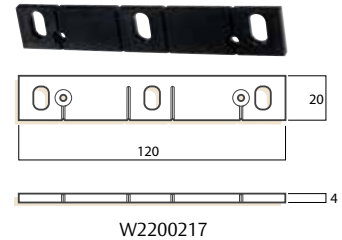

CYL4[®] Mini Push Lock

Application / Description

High security CYL4[®] compact window lock.

Features and Specifications

- CYL4[®] One Key Security - Can be matched to most door locks for one key convenience
- High security, robust construction, resists attack
- Simply push button to lock
- Solid zinc diecast metal body
- Stainless steel ferrule included
- Standard and one way fixing screws supplied
- Suits a wide variety of applications

Available in Display and Trade Packs.

Keying

- CYL4[®] cylinder - Can be Keyed Alike to all door locks that use a 5 pin key with a C4 profile, and to CYL4[®] window locks.
- Or - 5 disc wafer cylinder - Can be Keyed Alike to other Whitco 5 disc products.
- Two Whitco keys included

Standard polyester powder coat finishes

Silver	11
Mahogany	12
White	16
Black	17
Primrose	19



Display Pack

Includes Stainless Steel Ferrule

Single Pack - CYL4 Cylinder

W22080••

Trade Pack

Includes Stainless Steel Ferrule

CYL4 Cylinder - Keyed Alike

W22081••C4

5 Disc Wafer Cylinder - Keyed Alike

W22081••D5

•• Denotes finish. See price list for available pack / finish combinations

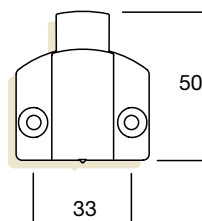
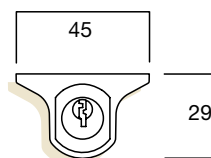

Unlocked Position

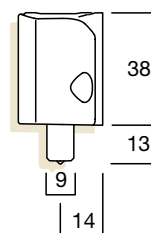

Locked Position

CYL4® Multi Bolt

Application / Description

High security CYL4® Multibolt window lock with concealed fixing.

Features and Specifications

- CYL4® One Key Security - Can be matched to most door locks for one key convenience
- High security, robust construction, resists attack
- Concealed fixing for security and style
- Versatile face fix or side fix design
- Key to lock, key to unlock
- Suits a wide variety of applications
- Enables fixed ventilation - (Sliding & Double Hung applications)
- Standard and one way fixing screws supplied
- Stainless steel ferrule for timber applications
- Ideal for double hung windows
- Strong 8mm steel bolts provided
- 3 bolt types supplied
- Solid zinc diecast metal body

Available in Display and Trade Packs.

Keying

- CYL4® cylinder - Can be Keyed Alike to all door locks that use a 5 pin key with a C4 profile, and to CYL4® window locks.
- Or - 5 disc wafer cylinder - Can be Keyed Alike to other Whitco 5 disc products.
- Two Whitco keys included

Standard polyester powder coat finishes

Silver	11
Mahogany	12
White	16
Black	17
Primrose	19



Aluminium Timber



Sliding



Casement



Awning



Double Hung

Display Pack

Includes Short and Long Thick Bolt, Long Thin Bolt and Side Fix Packer

Single Pack - CYL4 Cylinder W22051••

Quad Pack - Keyed Alike - CYL4 Cylinder W22050••

Trade Pack

Includes Short and Long Thick Bolt, Long Thin Bolt and Side Fix Packer

CYL4 Cylinder - Keyed Alike W22053••C4

5 Disc Wafer Cylinder - Keyed Alike W22053••D5

•• Denotes finish. See price list for available pack / finish combinations

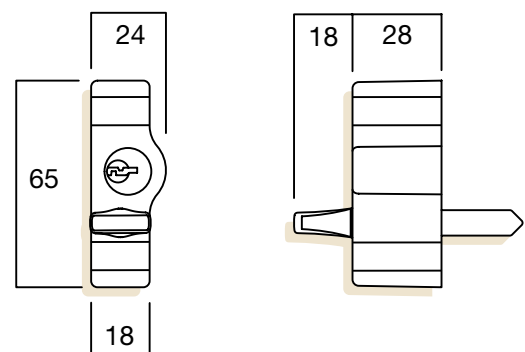

CYL4[®] Patio Bolt

Application / Description

Premium high security CYL4[®] Patio Bolt with concealed fixing.

Features and Specifications

- CYL4[®] One Key Security - Can be matched to most door locks for one key convenience
- High security, robust construction, resists attack
- Solid zinc diecast metal body
- Concealed fixing for security and style
- Key to lock, key to unlock
- Strong 9.5mm steel bolt
- 49mm bolt extension
- Bolt engages without locking for safety
- Reversible bolt for left or right handed installation
- Stainless steel ferrule for timber applications
- Allows door to be bolted in closed or venting positions - (Sliding door applications)
- Flat steel keeper for use when bolt doesn't engage door frame
- Extended (78mm bolt extension) versions available
- Single and Twin Keyed Alike display packs available

Available in Display and Trade Packs.

Keying

- CYL4[®] cylinder - Can be Keyed Alike to all door locks that use a 5 pin or 6 pin key with a C4 profile, and to CYL4[®] window locks.
- Or - 5 disc wafer cylinder - Can be Keyed Alike to other Whitco 5 disc products
- Two Whitco keys included

Standard polyester powder coat finishes

Silver	11
Mahogany	12
White	16
Black	17
Primrose	19

Non Standard Finishes

Not available.



- Aluminium
- Timber

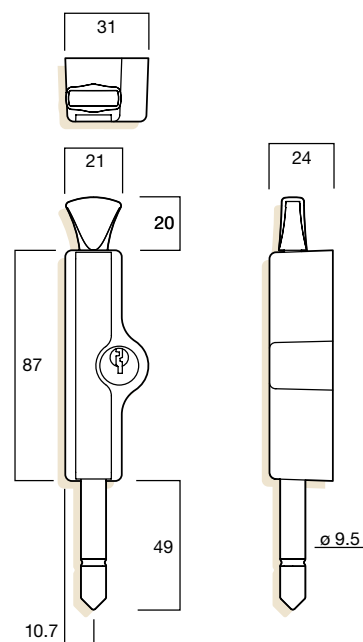
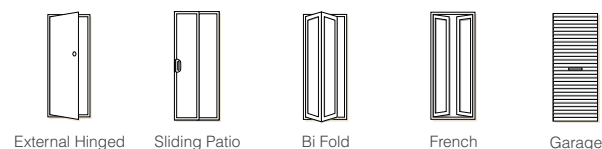

CYL4[®] Patio Bolt

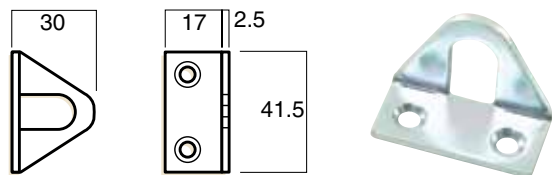

W2206701

Display Pack

Includes 2 x Stainless Steel Ferrules, 4mm Packer and Flat Keeper

Single Pack - CYL4 Cylinder	W22061••
Dual Pack - Keyed Alike - CYL4 Cylinder	W22068••

Trade Pack

Includes 2 x Stainless Steel Ferrules, 4mm Packer and Flat Keeper

CYL4 Cylinder - Keyed Alike	W22063••C4
5 Disc Wafer Cylinder - Keyed Alike	W22063••D5
CYL4 Cylinder with extended bolt - Keyed Alike	W2207517C4
5 Disc Wafer Cylinder with extended bolt - Keyed Alike	W2207517D5

Angle Keeper -	Zinc plated steel	W2206701
----------------	-------------------	----------

•• Denotes finish. See price list for available pack / finish combinations

CYL4[®] Window Bolt

Application / Description

High security CYL4[®] multi-purpose window bolt with concealed fixing.

Features and Specifications

- CYL4[®] One Key Security - Can be matched to most door locks for one key convenience
- High security, robust construction, resists attack
- Concealed fixing for security and style
- Key to lock, key to unlock
- Strong 9.5mm steel bolt
- Bolt engages without locking for safety
- Allows window to be locked in closed or secure ventilation position (sliding and double hung windows)
- Reversible bolt for left or right handed installation
- Solid zinc diecast metal body
- Stainless steel ferrule for timber applications

Available in Display and Trade Packs.

Keying

- CYL4[®] cylinder - Can be Keyed Alike to all door locks that use a 5 pin or 6 pin key with a C4 profile, and to CYL4[®] window locks.
- Or - 5 disc wafer cylinder - Can be Keyed Alike to other Whitco 5 disc products.
- Two Whitco keys included

Standard polyester powder coat finishes	
Silver	11
Mahogany	12
White	16
Black	17
Primrose	19

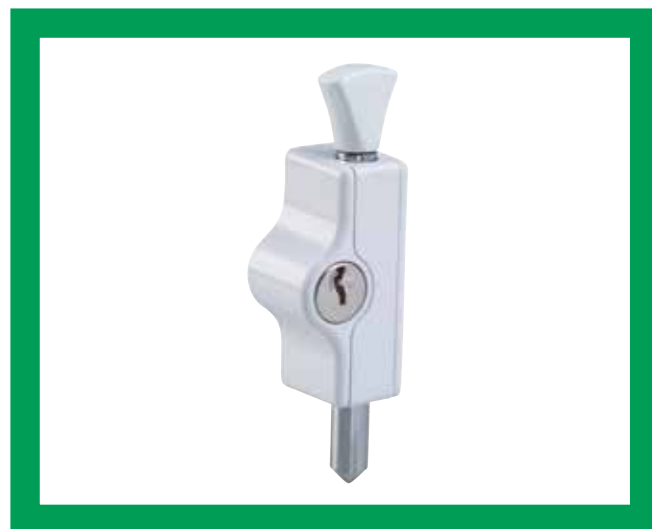

Display Pack

Includes Stainless Steel Ferrule and 4mm Packer

Single Pack W22031••

Trade Pack

Includes Stainless Steel Ferrule and 4mm Packer

CYL4 Cylinder - Keyed Alike W22033••C4

5 Disc Wafer Cylinder - Keyed Alike W22033••D5

•• Denotes finish. See price list for available pack / finish combinations

Accessories

Angle Keeper - Zinc plated steel W2206701

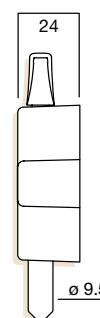
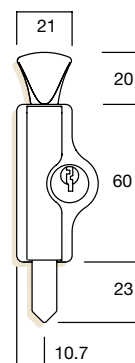
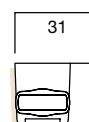

CYL4[®] Patio Bolt

Application / Description

High security CYL4[®] compact window bolt with concealed fixing.

Features and Specifications

- CYL4[®] One Key Security - Can be matched to most door locks for one key convenience
- High security, robust construction, resists attack
- Concealed fixing for security and style
- Key to lock, key to unlock
- Strong 8mm steel bolt
- Bolt engages without locking for safety
- Enables a secure ventilation position (sliding and double hung windows)
- Reversible bolt for left or right handed installation
- Solid zinc diecast metal body
- Stainless steel ferrule for timber applications
- Suits a wide variety of applications

Available in Display and Trade Packs.

Keying

- CYL4[®] cylinder - Can be Keyed Alike to all door locks that use a 5 pin or 6 pin key with a C4 profile, and to CYL4[®] window locks.
- Or - 5 disc wafer cylinder - Can be Keyed Alike to other Whitco 5 disc products.
- Two Whitco keys included

Standard polyester powder coat finishes

Silver	11
Mahogany	12
White	16
Black	17
Primrose	19



Display Pack

Includes Stainless Steel Ferrule and 4mm Packer

Single Pack CYL4 Cylinder

W22231••

Trade Pack

Includes Stainless Steel Ferrule and 4mm Packer

CYL4 Cylinder - Keyed Alike

W22230••C4

5 Disc Wafer Cylinder - Keyed Alike

W22230••D5

•• Denotes finish. See price list for available pack / finish combinations

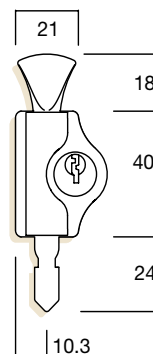
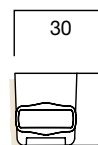

Keyed Sash Lock

Application / Description

Lockable swivel action double hung window lock.

Features and Specifications

- Swivel type two way action
- Key to lock and unlock
- Optional one way screws
- Range of keepers for timber and aluminium window applications
- Standard 16 mm and wide 26 mm bases available
- Australian made with imported cylinder

Available in Trade Pack only.

Keying

- 5 disc wafer cylinder
- Two Whitco chrome plated keys
- Can be key alike to other Whitco 5 disc products



Aluminium Timber



Standard finishes

Satin Chrome	05
Bright Chrome	08
White	16
Black	17
Primrose	19

Non Standard Finishes

Other polyester power coat finishes available on application.

Keepers

205, Stainless Steel	W271604
405, Stainless Steel	W272404
505, Stainless Steel	W271804
805, Stainless Steel	W271704
Comalco, Stainless Steel	W271904
Alcan, Stainless Steel	W272304
4 mm Standard base packer	W2714••

Trade Pack

Standard including fixing screws & standard keeper	W2733••
No Screws or Keeper	W2734••
Plain Wide Base including fixing screws & Standard keeper	W2736••
Standard base including fixing screws & Slimline keeper	W2740••

•• Denotes finish. See price list for available pack / finish combinations

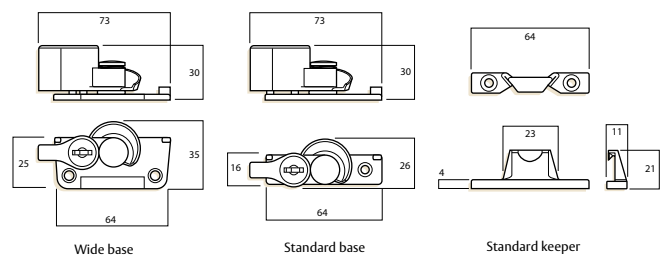

Safety Sash Lock

Application / Description

Swivel action double hung window lock.

Features and Specifications

- Swivel type two way action
- Self locking snib action – not key lockable
- Range of keepers for timber and aluminum window application
- Standard 16 mm and wide 26 mm bases available
- Lockable version is also available
- Australian made

Available in Trade Pack Only.

Standard finishes

Satin Chrome	05
Bright Chrome	08
White	16
Black	17
Primrose	19

Non Standard Finishes

Other polyester power coat finishes available on application.



Aluminium Timber



Double Hung

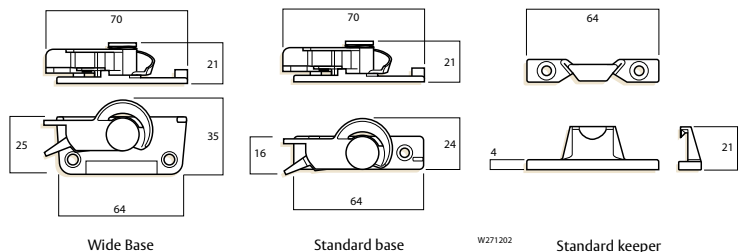

Wide Base

Standard base

W271202

Standard keeper

Trade Pack

Standard including fixing screws & standard keeper	W2702••
No Keeper or Screws	W2769••
Wide Base including fixing screws & standard keeper	W2795••

•• Denotes finish. See price list for available pack / finish combinations

Keepers

205, Stainless Steel	W271604
405, Stainless Steel	W272404
505, Stainless Steel	W271804
805, Stainless Steel	W271704
Comalco, Stainless Steel	W271904
Alcan, Stainless Steel	W272304
4 mm Standard base packer	W2714••

Safety Sash Lock

Beresfield 205 keeper - W271604

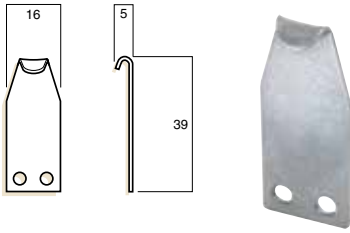

Comalco Keeper - W271904

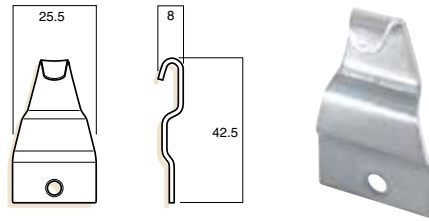

Modified Dowell 505 keeper - W271804

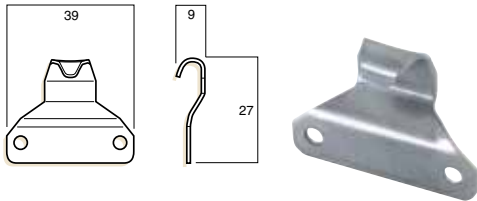

Alcan keeper - W272304

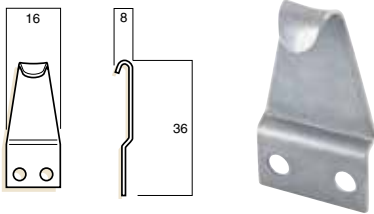

T259 805 keeper - W271704

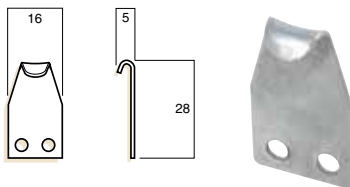

Base packer - aluminium

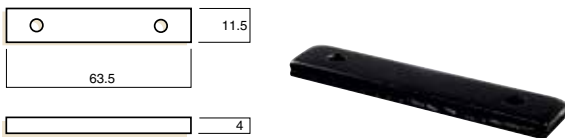

Dowell 405 keeper - W272404

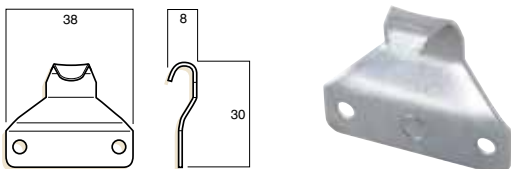

Sash lock with Dowell keeper	W2764••
Sash lock with modified Dowell keeper	W2765••
Sash lock with Alcan keeper	W2766••
4 mm Standard Base aluminium packer	W2714••

•• Denotes finish. See price list for available pack / finish combinations

Sliding Window Lock (Diecast)

Application / Description

Premium zinc diecast metal sliding window lock.

Features and Specifications

- Available in Lockable and Non-Lockable versions
- Zinc diecast construction
- Stylish design
- Spring loaded catch for automatic latching
- Strikes includes anti-bow lugs
- Push lever to open, pull lever to close
- Combination pull and fastener
- Strikes and packers available for aluminium and timber applications
- Key to lock and unlock
- Combination pull and fastener
- Australian made with imported cylinder

Available in Trade Pack Only.

Keying

- 5 disc wafer cylinder
- Two Whitco chrome plated keys
- Can be key alike to other Whitco 5 disc products



Aluminium Timber



Standard finishes

Satin Chrome	05
Bright Chrome	08
Black	17
White	16

Non Standard Finishes

Other polyester powder coat finishes available on application.

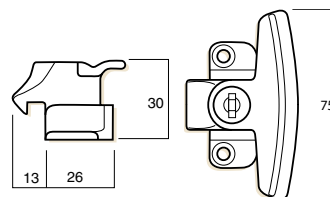

Lockable

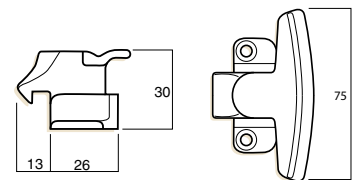

Non lockable

Sliding Window Lock (Diecast)

Body

Non-lockable body

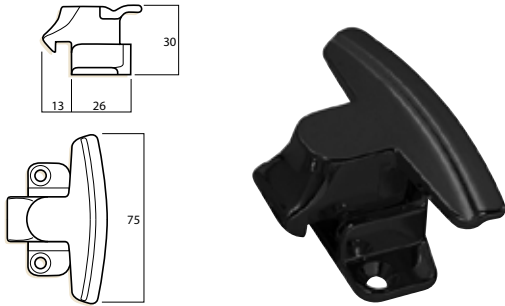

Lockable body

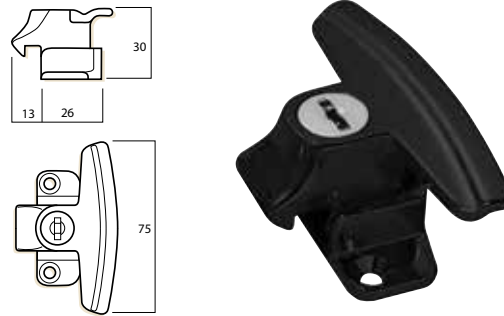

Strike

16 mm flat strike

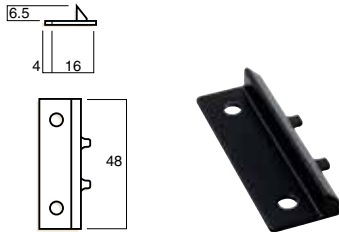

12 mm flat strike

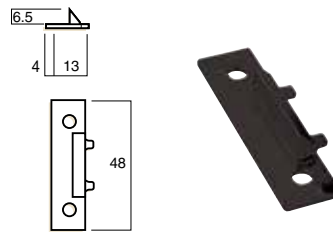

Timber frame strike

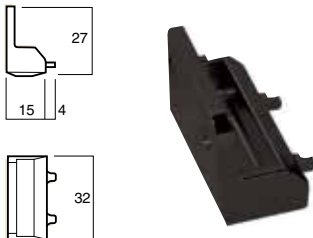

Sliding Window Lock (Diecast)

Standard Finishes

Strike packers / polymer

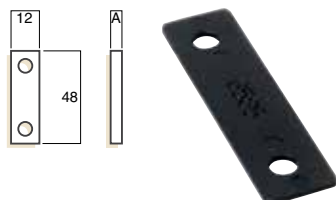

Body packers / polymer

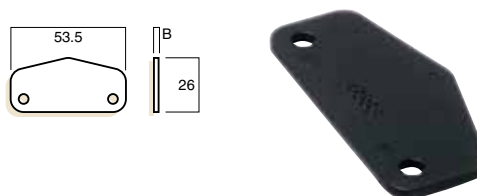

A	
2 mm	W286217
3 mm	W286317

B	
1 mm	W286417
2 mm	W286517
3 mm	W286617
4 mm	W286917

Trade Pack

Non-lockable with 12 mm flat strike	W2851••
Non-lockable with 16 mm wide flat strike	W2873••
Non-lockable with 22 mm timber frame strike	W2852••
Non-lockable with no strike	W2853••
Lockable with 12 mm flat strike	W2856••
Lockable with 16 mm flat strike	W2872••
Lockable with Timber frame strike	W2857••
Lockable with No strike (pack of 50)	W2858••

Packer - Strike / polymer-suits 12 mm flat strike

2 mm	W286217
3 mm	W286317

Packer - Body / zinc diecast

1 mm	W286417
2 mm	W286517
3 mm - body	W286617
4mm - body	W286917

Strike

16 mm aluminium frame strike	W2871••
------------------------------	---------

•• Denotes finish. See price list for available pack / finish combinations

Series 25 Window Lock

Application / Description

Contemporary lockable window fastener. Provides handle, pull and lock for window.

Features and Specifications

- Contemporary design
- Both Lockable and Non-Lockable versions available
- Positive fastening
- Left hand or right hand versions available
- Zinc diecast construction
- Range of strikes available
- Zinc diecast construction
- Combination pull and fastener
- Key to lock and unlock
- Australian made with imported cylinder

Available in Trade Pack Only.



Aluminium Timber

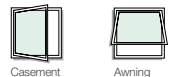

Keying

- 5 disc wafer cylinder
- Two Whitco chrome plated keys
- Can be key alike to other Whitco 5 disc products

Standard finishes

Satin Chrome	05
Bright Chrome	08
Black	17
White	16

Non Standard Finishes

Other polyester power coat finishes available on application.

Accessories

Flat keeper (20 pack) W229104.

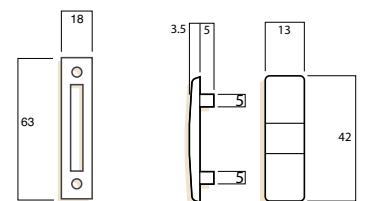

Flat keeper

3.5 mm Nylon Strike

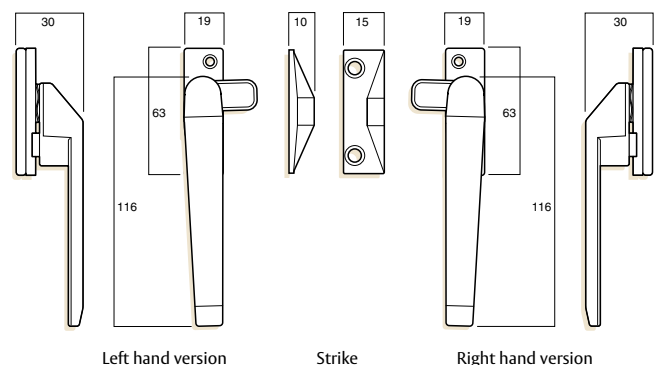

Left hand version

Strike

Right hand version

Trade Pack - Lockable

Standard / standard diecast	W2251•• (right hand)	W2252•• (left hand)
3.5 mm Nylon Strike Base / with standard base and 3.5 mm strike	W2253•• (right hand)	W2254•• (left hand)

Trade Pack - Non - Lockable

Standard / standard diecast	W2271•• (right hand)	W2272•• (left hand)
-----------------------------	----------------------	---------------------

•• Denotes finish. See price list for available pack / finish combinations

Whitco[®]

Whitco protects millions of Australian homes and offers the largest range of security and hardware products for residential doors and windows in Australia. With our proud heritage, and by offering a wide variety of locks at affordable prices, Whitco has become one of Australia's most trusted brands.

The Whitco brand is an integral part of ASSA ABLOY Australia Pty Limited, the market leader in the lock and security products industry in Australia.

ASSA ABLOY

ASSA ABLOY is the global leader in door opening solutions, dedicated to satisfying end-user needs for security, safety and convenience.

ASSA ABLOY is represented in all major regions, in both mature and emerging markets, with leading positions in Australia, Europe and North America.

As the world's leading lock group, ASSA ABLOY offers a more complete product range of door opening solutions than any other company in the market.

ASSA ABLOY Australia Pty Ltd
235 Huntingdale Road
Oakleigh, Victoria, 3166
Australia

info.au@assaabloy.com
assaabloy.com.au

ASSA ABLOY New Zealand Ltd
6 Armstrong Road
Albany, North Shore City, 0632
New Zealand

info.nz@assaabloy.com
assaabloy.co.nz

An ASSA ABLOY Group brand

Disclaimer
Whilst every effort has been made to ensure that the information contained in this brochure is accurate at the time of publication, ASSA ABLOY Australia Pty Limited ("ASSA ABLOY") recommends that you consult ASSA ABLOY or its agents prior to placing an order to ascertain current information on specific products, as ASSA ABLOY reserves the right to make any changes without notice. ASSA ABLOY will not be liable for any injury, loss or damage whatsoever, arising from any errors or omissions in the information contained in the brochure or arising from the use or application of the information contained herein.